

---

## Sup/IRBuck™

### USER GUIDE FOR IR3895 EVALUATION BOARD

#### 1.2Vout

#### DESCRIPTION

The IR3895 is a synchronous buck converter, providing a compact, high performance and flexible solution in a small 5mm X 6 mm Power QFN package.

Key features offered by the IR3895 include internal Digital Soft Start/Soft Stop, precision 0.5V reference voltage, Power Good, thermal protection, programmable switching frequency, Enable input, input under-voltage lockout for proper start-up, enhanced line/load regulation with feed forward, external frequency synchronization with smooth clocking, smart internal LDO and pre-bias start-up.

Output over-current protection function is implemented by sensing the voltage developed across the on-resistance of the synchronous rectifier MOSFET for optimum cost and performance and the current limit is thermally compensated.

This user guide contains the schematic and bill of materials for the IR3895 evaluation board. The guide describes operation and use of the evaluation board itself. Detailed application information for IR3895 is available in the IR3895 data sheet.

---

#### BOARD FEATURES

- $V_{in} = +12V (+ 13.2V \text{ Max})$
- $V_{out} = +1.2V @ 0- 16A$
- $F_s = 600kHz$
- $L = 0.4\mu H$
- $C_{in} = 5 \times 10\mu F$  (ceramic 1206) +  $1 \times 330\mu F$  (electrolytic)
- $C_{out} = 6 \times 47\mu F$  (ceramic 0805)

## CONNECTIONS AND OPERATING INSTRUCTIONS

A well regulated +12V input supply should be connected to VIN+ and VIN-. A maximum of 16A load should be connected to VOUT+ and VOUT-. The input and output connections of the board are listed in Table I.

IR3895 has only one input supply and internal LDO generates Vcc from Vin. If operation with external Vcc is required, then R15 can be removed and external Vcc can be applied between Vcc+ and Vcc- pins. Vin pin and Vcc/LDOout pins should be shorted together for external Vcc operation (use zero ohm resistor for R29).

The output can track voltage at the Vp pin. For this purpose, Vref pin is to be connected to ground (use zero ohm resistor for R21). The value of R14 and R28 can be selected to provide the desired tracking ratio between output voltage and the tracking input.

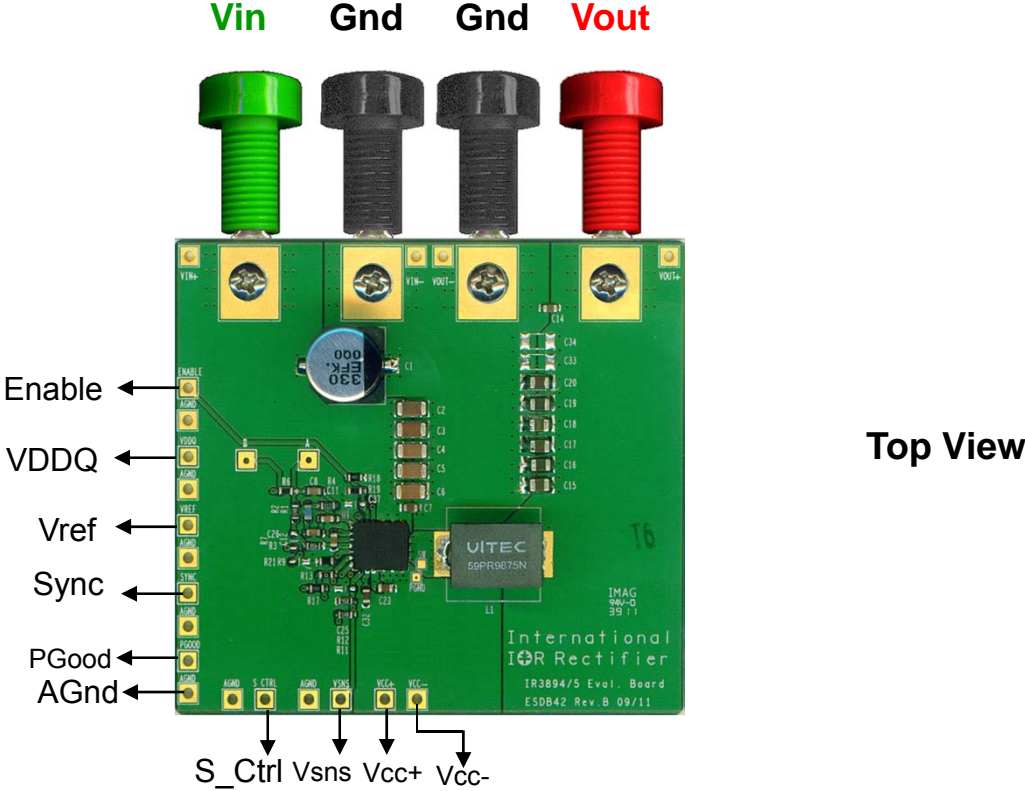
**Table I. Connections**

| Connection | Signal Name          |
|------------|----------------------|
| VIN+       | Vin (+12V)           |
| VIN-       | Ground of Vin        |
| Vout+      | Vout(+1.2V)          |
| Vout-      | Ground for Vout      |
| Vcc+       | Vcc/ LDO_out Pin     |
| Vcc-       | Ground for Vcc input |
| Enable     | Enable               |
| PGood      | Power Good Signal    |
| Gnd        | Analog ground        |

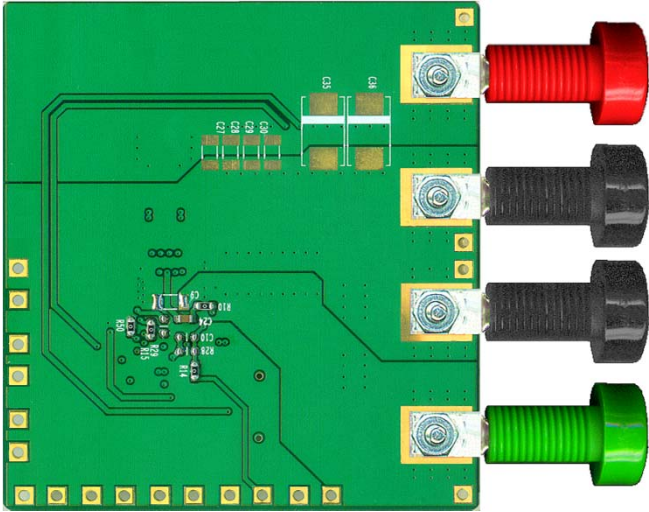
## LAYOUT

The PCB is a 4-layer board (2.23"x2") using FR4 material. All layers use 2 Oz. copper. The PCB thickness is 0.062". The IR3895 and other major power components are mounted on the top side of the board.

Power supply decoupling capacitors, the bootstrap capacitor and feedback components are located close to IR3895. The feedback resistors are connected to the output at the point of regulation and are located close to the SupIRBuck IC. To improve efficiency, the circuit board is designed to minimize the length of the on-board power ground current path.

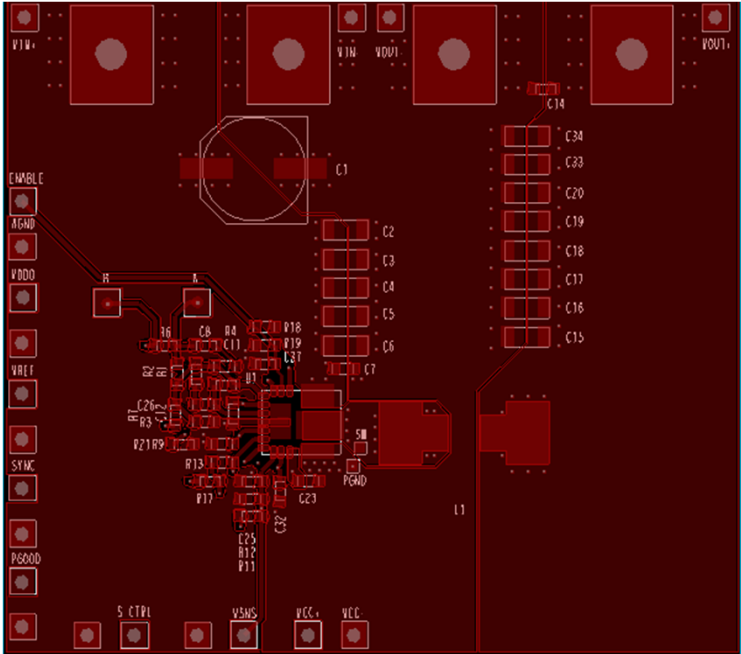


**Top View**

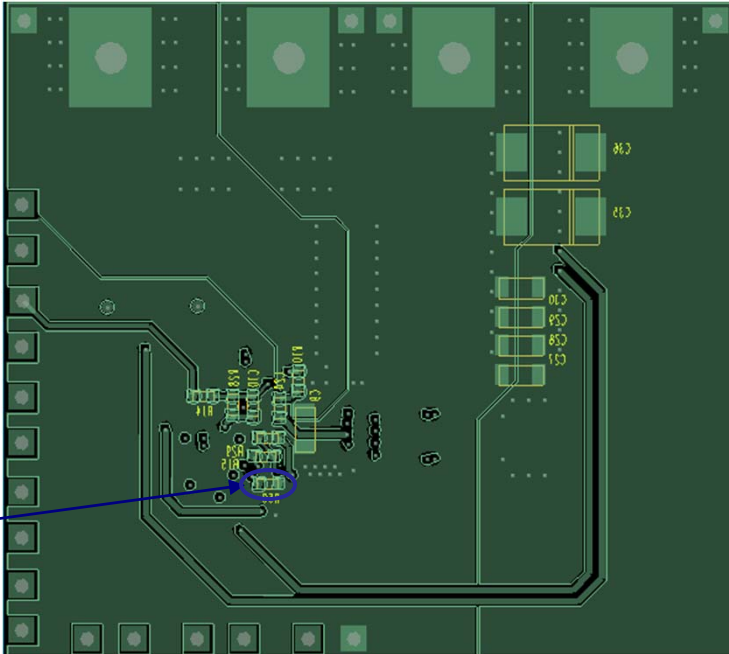


**Bottom View**

**Fig. 1: Connection Diagram of IR3895/94 Evaluation Boards**

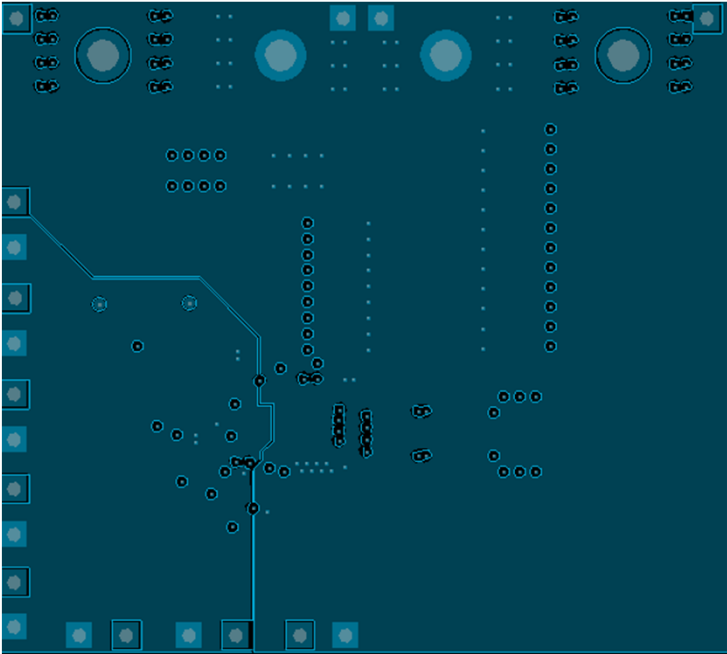


**Fig. 2: Board Layout-Top Layer**

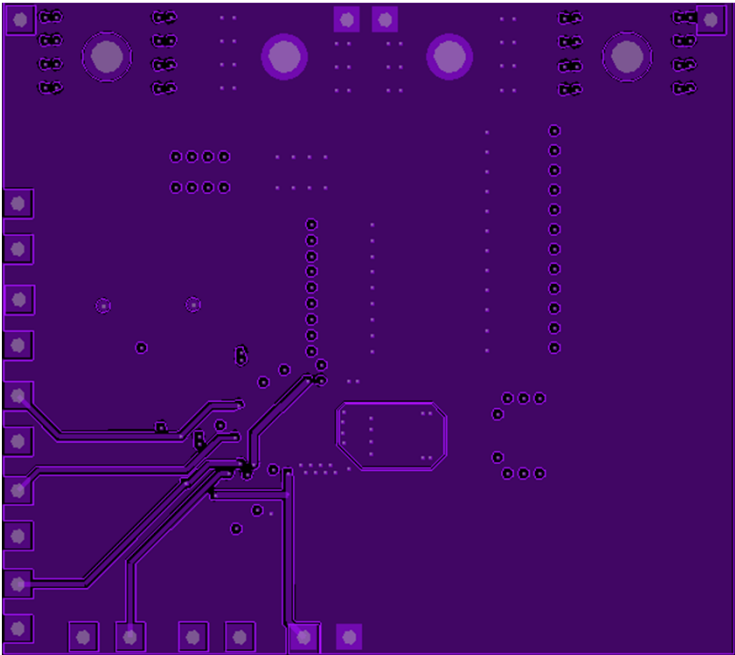


Single point connection between  
Analog Gnd and PGnd

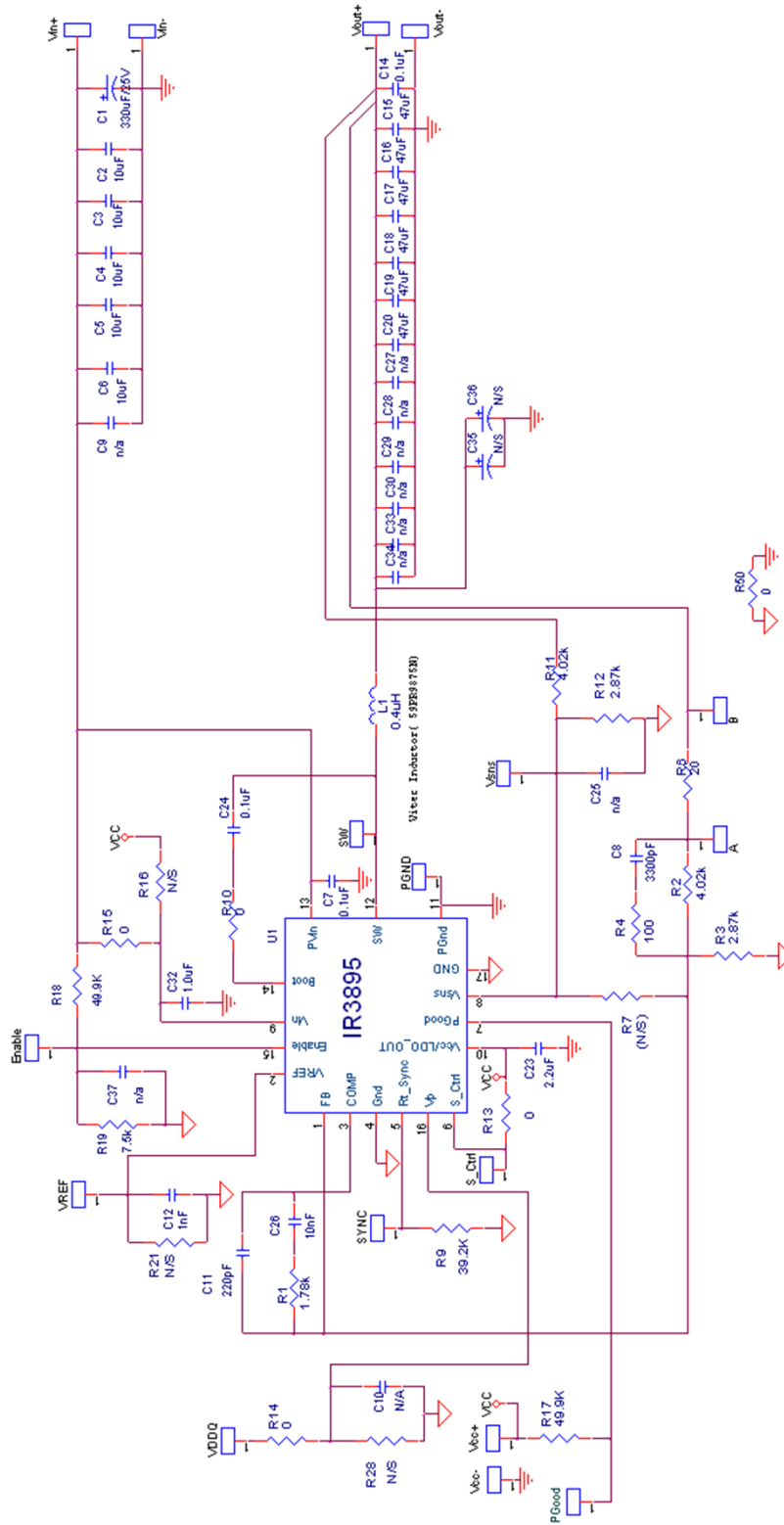
**Fig. 3: Board Layout-Bottom Layer**



**Fig. 4: Board Layout-Mid Layer 1**



**Fig. 5: Board Layout-Mid Layer 2**



**Fig. 6: Schematic of the IR3895 evaluation board**

Bill of Materials

| Item | Qty | Part Reference          | Value  | Description                     | Manufacturer | Part Number        |
|------|-----|-------------------------|--------|---------------------------------|--------------|--------------------|
| 1    | 1   | C1                      | 330uF  | SMD Electrolytic F size 25V 20% | Panasonic    | EEV-FK1E331P       |
| 2    | 5   | C2 C3 C4 C5 C6          | 10uF   | 1206, 25V, X5R, 20%             | TDK          | C3216X5R1E106M     |
| 3    | 3   | C7 C14 C24              | 0.1uF  | 0603, 25V, X7R, 10%             | Murata       | GRM188R71E104KA01B |
| 4    | 1   | C12                     | 1nF    | 0603, 25V, COG, 5%              | Murata       | GRM1885C1E102JA01D |
| 5    | 1   | C8                      | 3300pF | 0603,50V,X7R,10%                | Murata       | GRM188R71H332KA01B |
| 6    | 1   | C11                     | 220pF  | 0603, 50V, COG, 5%              | Murata       | GRM1885C1H221JA01D |
| 7    | 6   | C15 C16 C17 C18 C19 C20 | 47uF   | 0805, 6.3V, X5R, 20%            | TDK          | C2012X5R0J476M     |
| 8    | 1   | C23                     | 2.2uF  | 0603, 16V, X5R, 20%             | TDK          | C1608X5R1C475M     |
| 9    | 1   | C26                     | 10nF   | 0603, 25V, X7R, 10%             | Murata       | GRM188R71E103KA01J |
| 10   | 1   | C32                     | 1.0uF  | 0603, 25V, X5R, 10%             | Murata       | GRM188R61E105KA12D |
| 111  | 1   | L1                      | 0.4uH  | SMD 11.0x7.2x7.5mm,0.29mΩ       | Vitec        | 59PR9875N          |
| 12   | 1   | R1                      | 1.78k  | Thick Film, 0603,1/10W,1%       | Panasonic    | ERJ-3EKF17801V     |
| 13   | 2   | R2 R11                  | 4.02k  | Thick Film, 0603,1/10W,1%       | Panasonic    | ERJ-3EKF4021V      |
| 14   | 2   | R3 R12                  | 2.87k  | Thick Film, 0603,1/10W,1%       | Panasonic    | ERJ-3EKF2871V      |
| 15   | 1   | R4                      | 100    | Thick Film, 0603,1/10W,1%       | Panasonic    | ERJ-3EKF1000V      |
| 16   | 1   | R6                      | 20     | Thick Film, 0603,1/10W,1%       | Panasonic    | ERJ-3EKF20R0V      |
| 17   | 1   | R9                      | 39.2k  | Thick Film, 0603,1/10W,1%       | Panasonic    | ERJ-3EKF3922V      |
| 18   | 5   | R10 R13 R14 R15 R50     | 0      | Thick Film, 0603,1/10W          | Panasonic    | ERJ-3GEY0R00V      |
| 19   | 2   | R17 R18                 | 49.9k  | Thick Film, 0603,1/10W,1%       | Panasonic    | ERJ-3EKF4992V      |
| 20   | 1   | R19                     | 7.5k   | Thick Film, 0603,1/10W,1%       | Panasonic    | ERJ-3EKF7551V      |
| 21   | 1   | U1                      | IR3895 | PQFN 5x6mm                      | IR           | IR3895MPBF         |

## TYPICAL OPERATING WAVEFORMS

$V_{in}=12.0V$ ,  $V_o=1.2V$ ,  $I_o=0-16A$ , Room Temperature, no airflow

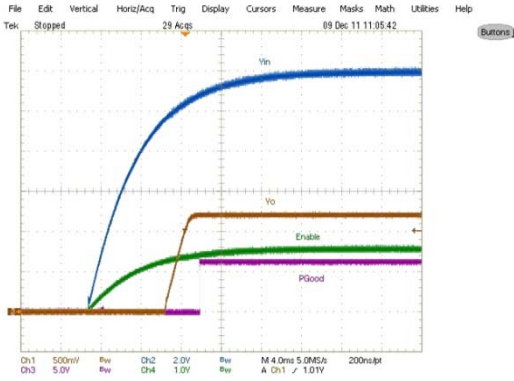


Fig. 7: Start up at 16A Load  
Ch<sub>1</sub>:V<sub>out</sub>, Ch<sub>2</sub>:V<sub>in</sub>, Ch<sub>3</sub>:PGood, Ch<sub>4</sub>:Enable

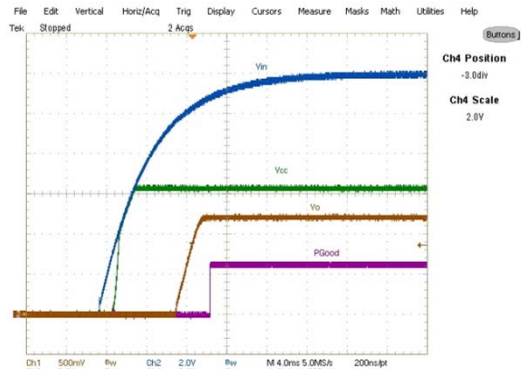


Fig. 8: Start up at 16A Load  
Ch<sub>1</sub>:V<sub>out</sub>, Ch<sub>2</sub>:V<sub>in</sub>, Ch<sub>3</sub>:PGood, Ch<sub>4</sub>:Vcc

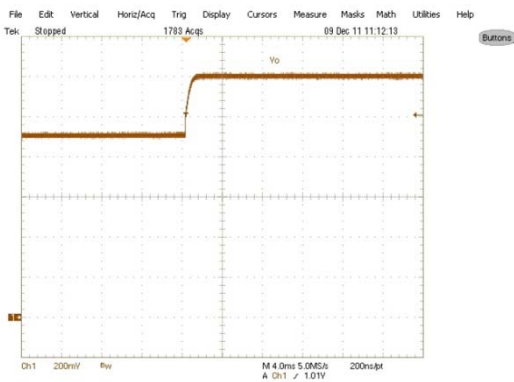


Fig. 9: Start up with Pre Bias , 0A Load,  
Ch<sub>1</sub>:V<sub>o</sub>

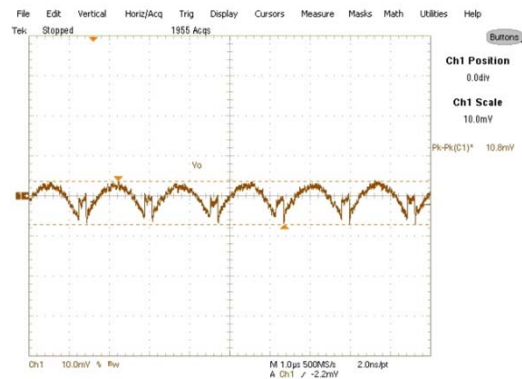


Fig. 10: Output Voltage Ripple, 16A load  
Ch<sub>1</sub>: V<sub>out</sub> ,

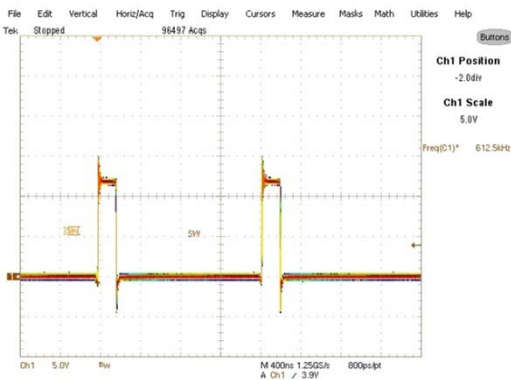


Fig. 11: Inductor node at 16A load  
Ch<sub>1</sub>:Switch Node

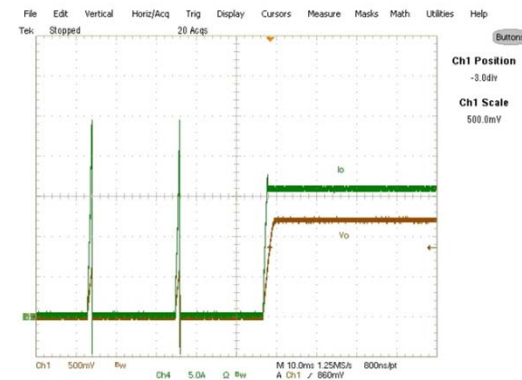


Fig. 12: Short circuit (Hiccup) Recovery  
Ch<sub>1</sub>:V<sub>out</sub> , Ch<sub>4</sub>:Iout



**TYPICAL OPERATING WAVEFORMS**

Vin=12.0V, Vo=1.2V, Io=0-16A, Room Temperature, no air flow

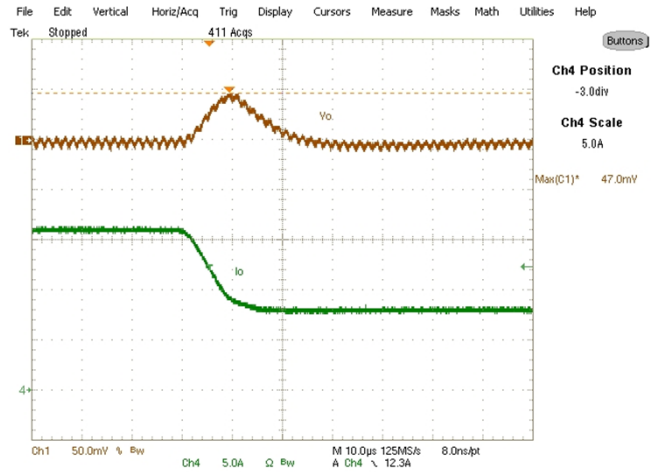
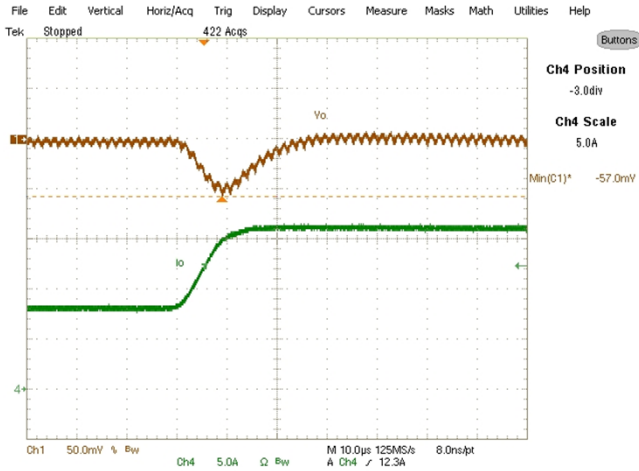
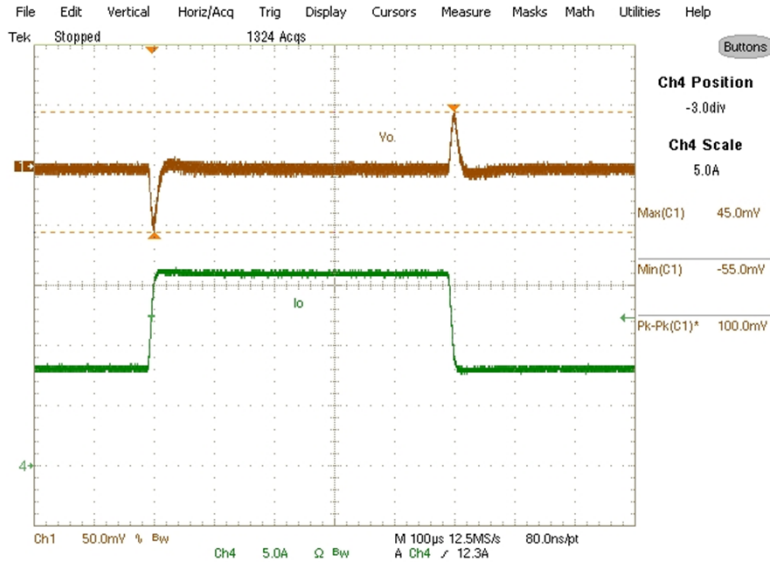


Fig. 13: Transient Response, 8A to 16A step @2.5A/usec slew rate  
Ch1: V<sub>out</sub> Ch4: I<sub>out</sub>

**TYPICAL OPERATING WAVEFORMS**  
**Vin=12.0V, Vo=1.2V, Io=0-16A, Room Temperature**

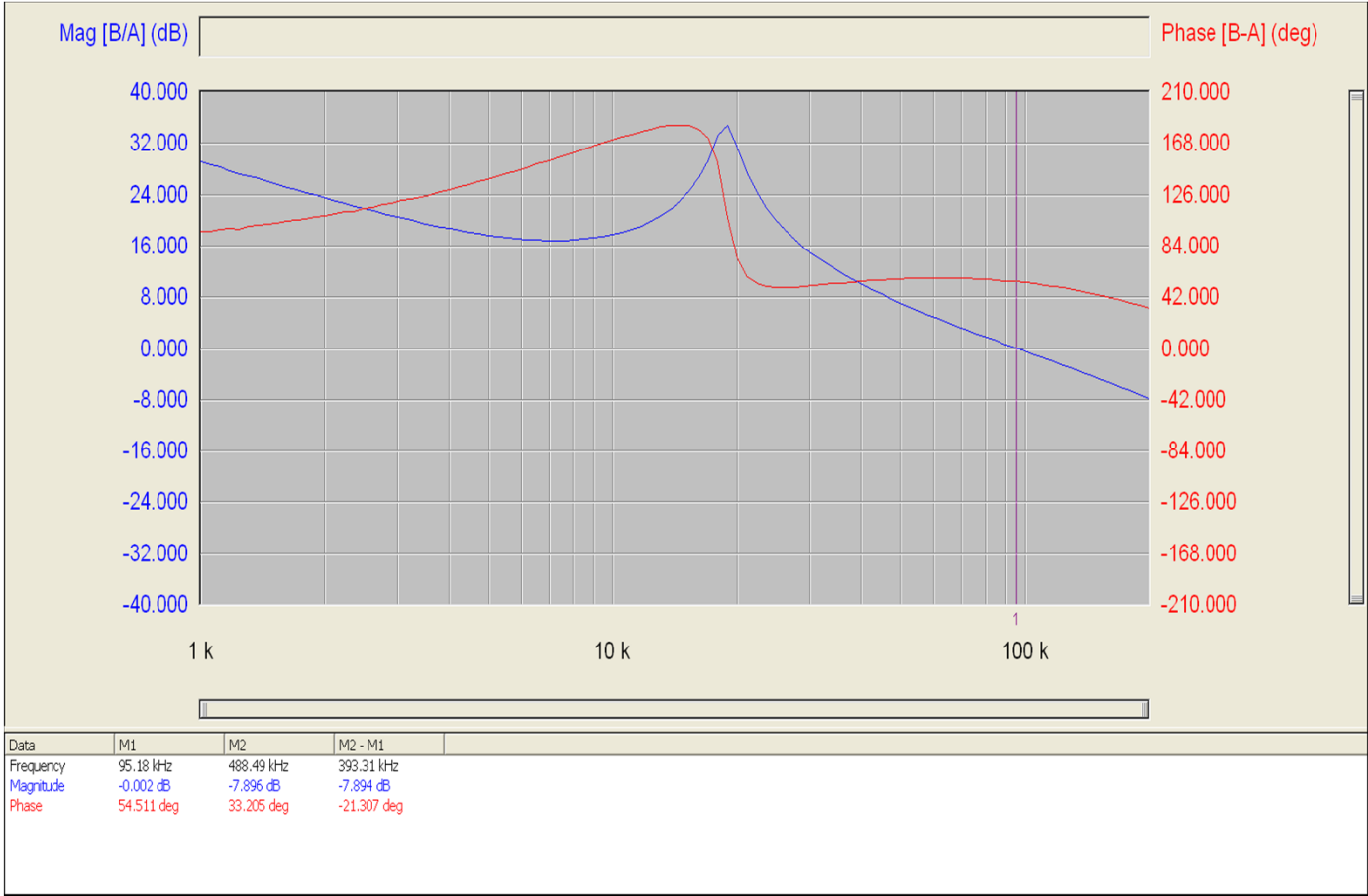


Fig. 14: Bode Plot at 16A load shows a bandwidth of 95.2kHz and phase margin of 54.5°

**TYPICAL OPERATING WAVEFORMS**

**V<sub>in</sub>=12.0V, V<sub>o</sub>=1.2V, I<sub>o</sub>=0-16A, Room Temperature, no air flow**

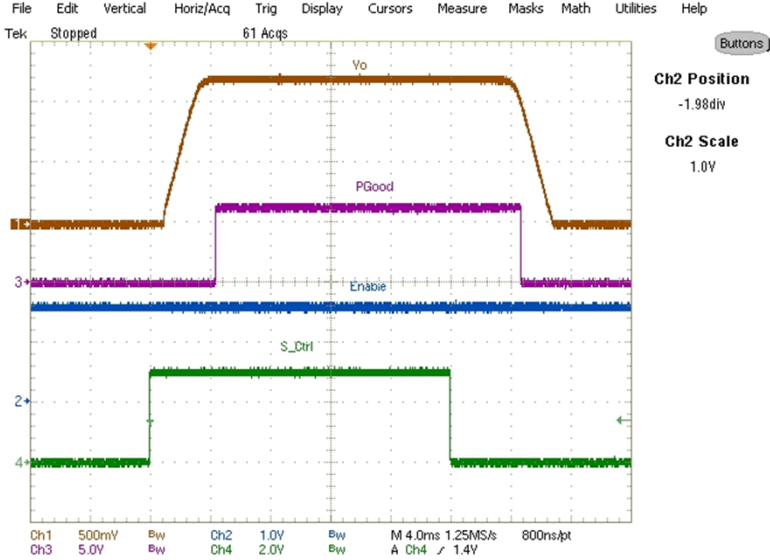


Fig (15) Soft start and soft stop using S\_Ctrl pin

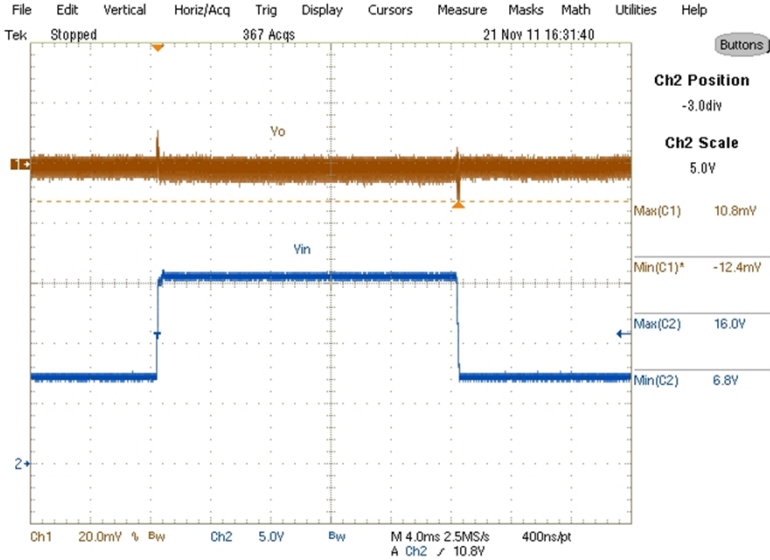


Fig (16) Feed Forward for Vin change from 6.8 to 16V and back to 6.8V  
Ch<sub>1</sub>-V<sub>out</sub> Ch<sub>4</sub>-V<sub>in</sub>

**TYPICAL OPERATING WAVEFORMS**

Vin=12.0V, Vo=1.2V, Io=0-16A, Room Temperature, no air flow

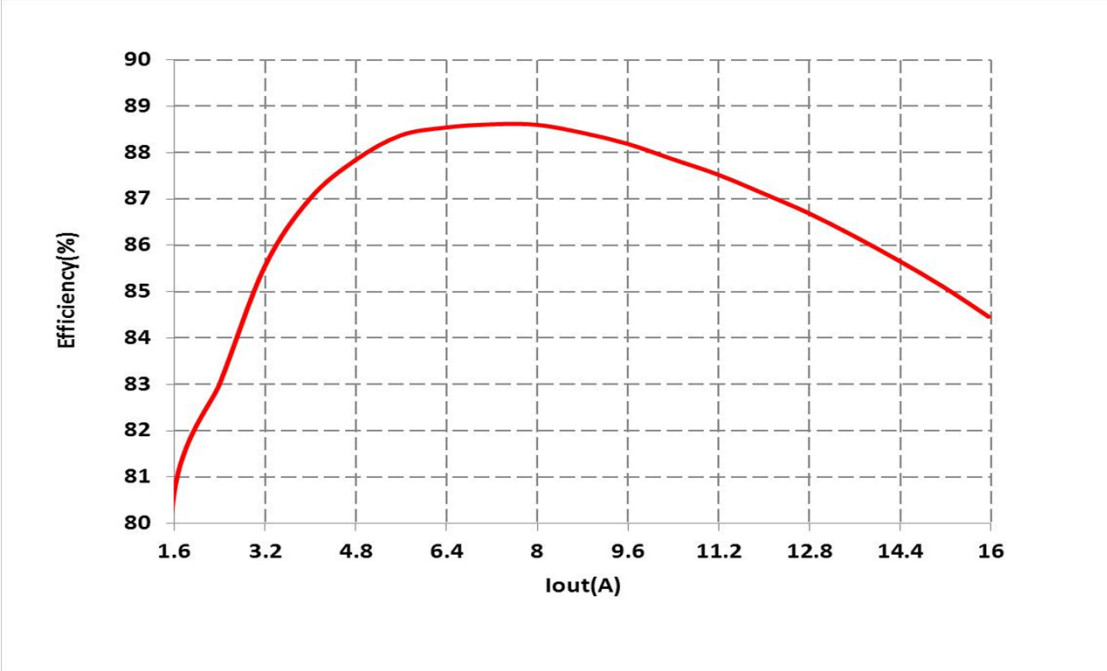


Fig.17: Efficiency versus load current

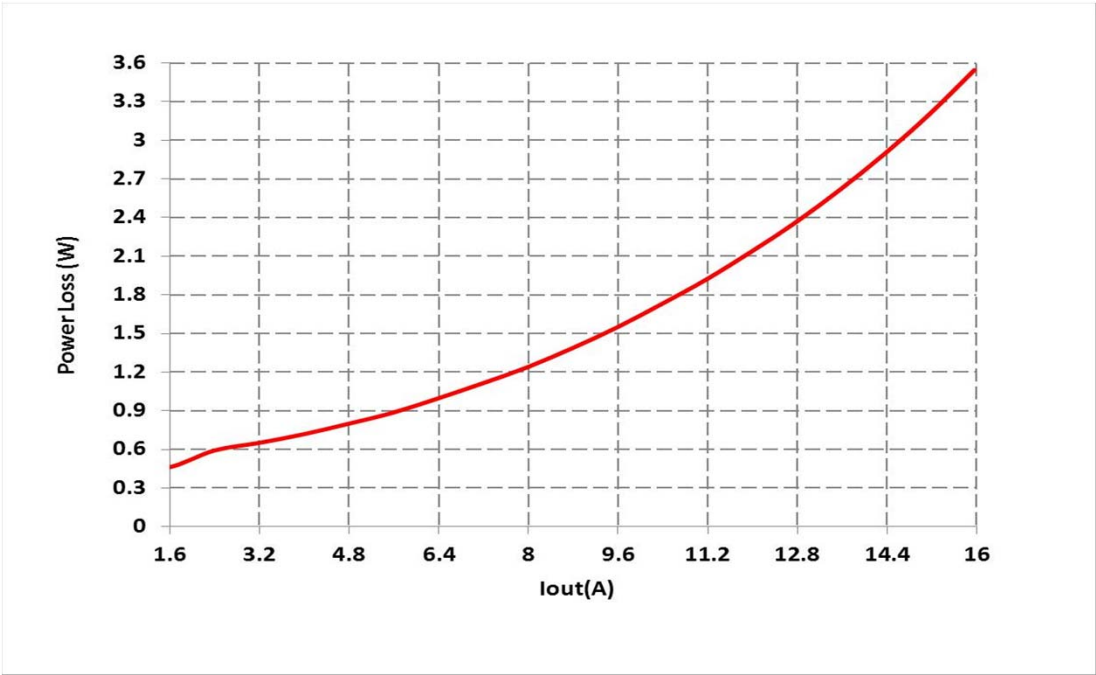


Fig.18: Power loss versus load current

**THERMAL IMAGES**

Vin=12.0V, Vo=1.2V, Io=0-16A, Room Temperature, No Air flow



Fig. 19: Thermal Image of the board at 16A load  
Test point 1 is IR3895  
Test point 2 is inductor

PACKAGE INFORMATION

| DIM | MILIMITERS  |       | INCHES       |        | DIM        | MILIMITERS  |       | INCHES       |        |
|-----|-------------|-------|--------------|--------|------------|-------------|-------|--------------|--------|
|     | MIN         | MAX   | MIN          | MAX    |            | MIN         | MAX   | MIN          | MAX    |
| A   | 0.800       | 1.000 | 0.0315       | 0.0394 | L          | 0.350       | 0.450 | 0.0138       | 0.0177 |
| A1  | 0.000       | 0.050 | 0.0000       | 0.0020 | M          | 2.441       | 2.541 | 0.0961       | 0.1000 |
| b   | 0.375       | 0.475 | 0.1477       | 0.1871 | N          | 0.703       | 0.803 | 0.0277       | 0.0316 |
| b1  | 0.250       | 0.350 | 0.0098       | 0.1379 | O          | 2.079       | 2.179 | 0.0819       | 0.0858 |
| c   | 0.203 REF.  |       | 0.008 REF.   |        | P          | 3.242       | 3.342 | 0.1276       | 0.1316 |
| D   | 5.000 BASIC |       | 1.969 BASIC  |        | Q          | 1.265       | 1.365 | 0.0498       | 0.0537 |
| E   | 6.000 BASIC |       | 2.362 BASIC  |        | R          | 2.644       | 2.744 | 0.1041       | 0.1080 |
| e   | 1.033 BASIC |       | 0.0407 BASIC |        | S          | 1.500       | 1.600 | 0.0591       | 0.0630 |
| e1  | 0.650 BASIC |       | 0.0256 BASIC |        | t1, t2, t3 | 0.401 BASIC |       | 0.016 BACIS  |        |
| e2  | 0.852 BASIC |       | 0.0335 BASIC |        | t4         | 1.153 BASIC |       | 0.045 BASIC  |        |
|     |             |       |              |        | t5         | 0.727 BASIC |       | 0.0286 BASIC |        |

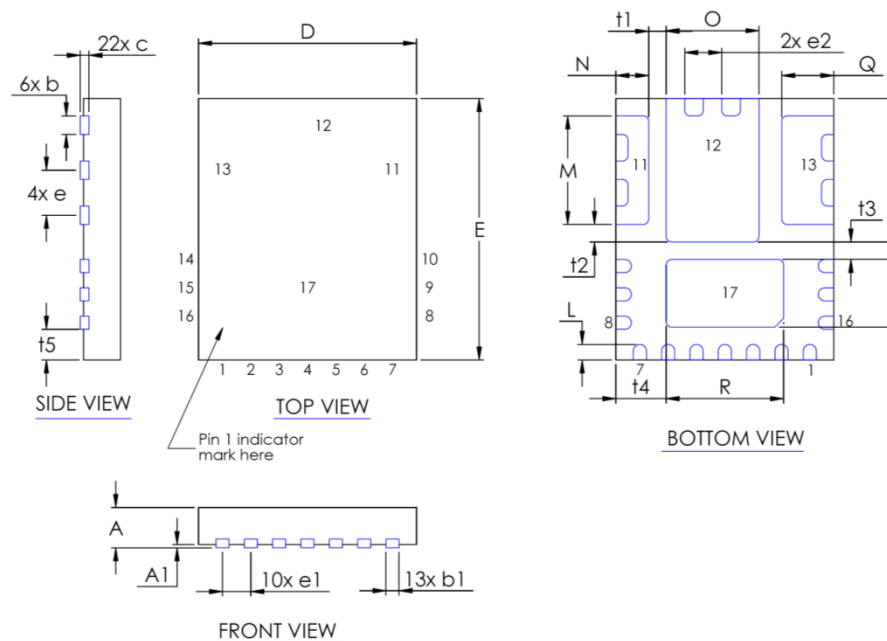


Figure 20: Package Dimensions

**IR WORLD HEADQUARTERS:** 233 Kansas St., El Segundo, California 90245, USA Tel: (310) 252-7105

TAC Fax: (310) 252-7903

**This product has been designed and qualified for the Industrial market**

Visit us at [www.irf.com](http://www.irf.com) for sales contact information

*Data and specifications subject to change without notice. 12/11*